

# Burners for gas BIC, BICA, BICW

## OPERATING INSTRUCTIONS

· Edition 09.22 · EN · 03250467

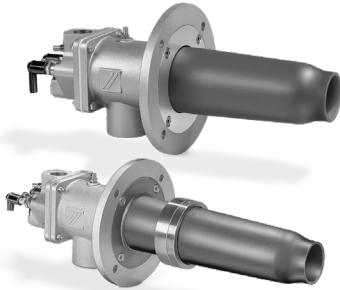

### CONTENTS

1 Safety	1
2 Checking the usage	2
3 Installation	3
4 Wiring	6
5 Preparing commissioning	6
6 Commissioning	10
7 Maintenance	12
8 Assistance in the event of malfunction	14
9 Accessories	14
10 Technical data	15
11 Logistics	15
12 Disposal	15
13 Declaration of Incorporation	16
14 Certification	16

## 1 SAFETY

### 1.1 Please read and keep in a safe place



Please read through these instructions carefully before installing or operating. Following the installation, pass the instructions on to the operator. This unit must be installed and commissioned in accordance with the regulations and standards in force. These instructions can also be found at [www.docuthek.com](http://www.docuthek.com).

### 1.2 Explanation of symbols

**1, 2, 3, a, b, c** = Action

→ = Instruction

### 1.3 Liability

We will not be held liable for damage resulting from non-observance of the instructions and non-compliant use.

### 1.4 Safety instructions

Information that is relevant for safety is indicated in the instructions as follows:

#### **⚠ DANGER**

Indicates potentially fatal situations.

#### **⚠ WARNING**

Indicates possible danger to life and limb.

#### **⚠ CAUTION**

Indicates possible material damage.

All interventions may only be carried out by qualified gas technicians. Electrical interventions may only be carried out by qualified electricians.

### 1.5 Conversion, spare parts

All technical changes are prohibited. Only use OEM spare parts.

## 2 CHECKING THE USAGE

Burner for heating industrial thermoprocessing equipment. Burners BIC or BICA can be used in conjunction with the ceramic tube set TSC in industrial furnaces or firing systems with brick lining or ceramic fibre lining. No burner block is necessary. For natural gas, town gas and LPG. Other types of gas on request. This function is only guaranteed when used within the specified limits – see also page 15 (10 Technical data). Any other use is considered as non-compliant.

### 2.1 Type label

Construction stage, rated capacity  $Q_{max}$ , gas type and diameter of gas measuring orifice (as of construction stage E) – see type label.

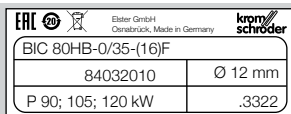

### 2.2 Type code

<b>BIC</b>	Burner for gas, with connection for ceramic tube
<b>BICA</b>	Burner for gas, with aluminium housing and connection for ceramic tube
<b>BICW</b>	Burner for gas, with ceramic fibre insulation (RCF)
<b>50-140</b>	Burner size
<b>R</b>	Cold air
<b>H</b>	Hot air/high furnace temperature
<b>L</b>	For high excess air and a large ignition range
<b>M</b>	For menox low NOx operation
<b>B</b>	Natural gas
<b>D</b>	Coke oven gas, town gas
<b>G</b>	Propane, propane/butane, butane
<b>M</b>	Propane, propane/butane, butane (with mixer)
<b>L</b>	Low calorific value gas
<b>F</b>	Biogas
<b>L</b>	integrated pilot
<b>R</b>	Reduced capacity
<b>-X</b>	X mm length of steel tube as of furnace flange (L1)
<b>/X</b>	X mm distance from furnace flange to front edge of burner head (L2)
<b>-(X)</b>	Burner head identifier
<b>-(XE)</b>	Heat-resistant version
<b>A-Z</b>	Construction stage
<b>H</b>	High temperature version

## 2.3 Part designations

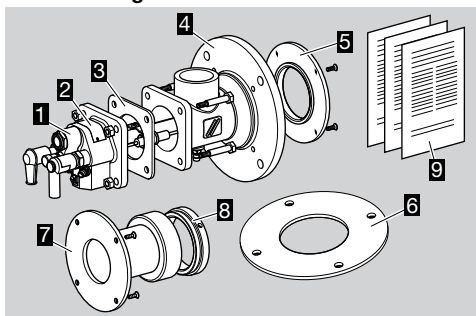

- 1 Burner insert
- 2 Type label
- 3 Gas housing gasket
- 4 Air housing
- 5 Mounting flange for TSC (for BIC(A)..-0)
- 6 Mounting gasket (not included in the delivery)
- 7 Burner extension with clamping ring (for BIC(A)..-100, -200 ...)
- 8 Clamping ring
- 9 Operating instructions – for more documents and calculation tools, see [www.adlatus.org](http://www.adlatus.org)

### 2.4 Burner head

→ Check letter marking and identification marks on the burner head using the information provided on the type label.

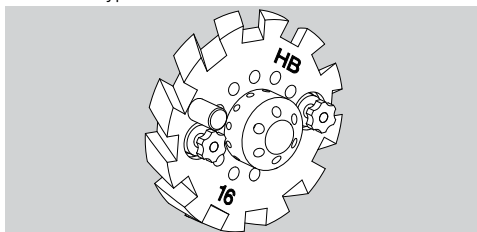

### 2.5 Ceramic tube

#### Type label

Length and diameter – see type label.



### 2.6 Type code

<b>TSC</b>	Ceramic tube set
<b>50-140</b>	Burner size
<b>A</b>	Cylindrical shape
<b>B</b>	Tapered shape
<b>020-180</b>	Outlet diameter [mm]
<b>200-300</b>	Length [mm]
<b>/35-, /135-</b>	Distance from furnace flange to front edge of burner baffle plate [mm]
<b>Si</b>	Silicon-infiltrated SiC
<b>1500</b>	Up to 1500°C

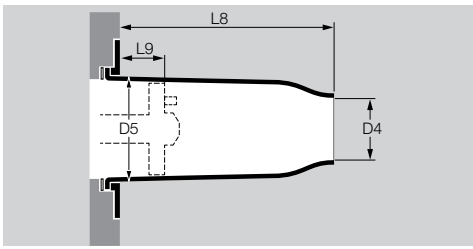

## 2.7 Part designations

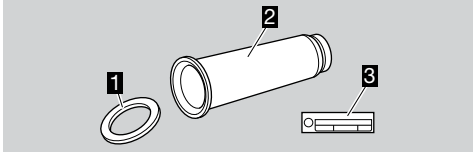

- 1 Burner tube gasket
- 2 Ceramic tube
- 3 Type label

## 3 INSTALLATION

### 3.1 Installing the ceramic tube

#### **⚠ WARNING**

- Install the ceramic tube centrally and free of mechanical stress to avoid damage. Remove and dispose of the transport safety device; to do this, remove the mounting flange or clamping ring.
- Remove the burner insert in order to install the ceramic tube. For this purpose, the air housing can be placed in a vertical position on a smooth working surface.
- On BICW, avoid the formation of dust when dismantling the burner insert and do not damage the surface of the internal insulation.

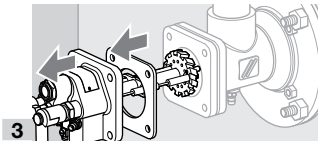
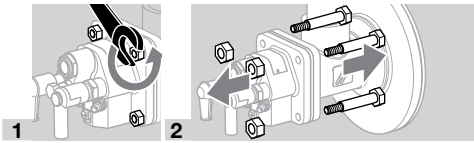

- 3
- 4 Place the burner insert in such a way that the insulators are protected against damage.

### No burner extension

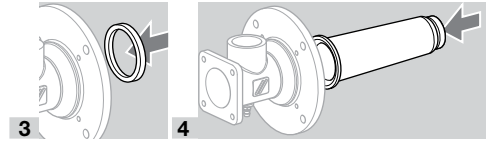
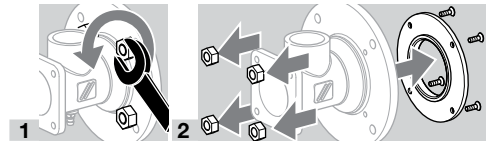

- Centre the ceramic tube.

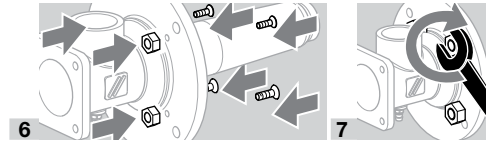
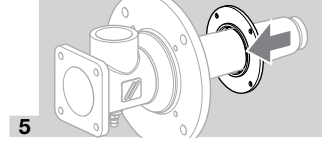

- Tighten the screws in a crosswise fashion.
- Mounting flange and furnace flange must be flush.

### With burner extension

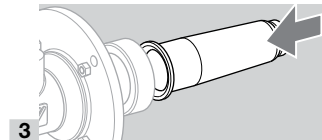
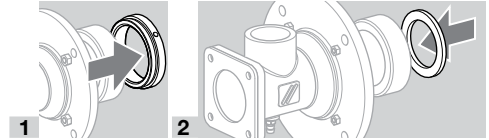

- Centre the ceramic tube.

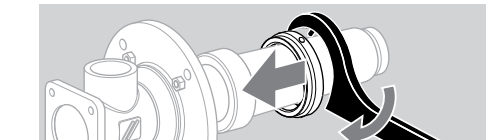

- 4
- Tighten the clamping ring as far as it will go.
- 'C' spanner, see page 14 (9 Accessories).

### 3.2 Insulating the ceramic tube

- Protect the burner extension from thermal stress.
- We recommend solid shaped parts A or high temperature resistant ceramic fibrous material B for insulation.
- Observe an annular void of at least 10 mm (0.4 inches).

→ Insulate the ceramic tube at least as far as the burner head, to a maximum of 20 mm (0.8 inches) behind the burner head.

→ Burners without extension:

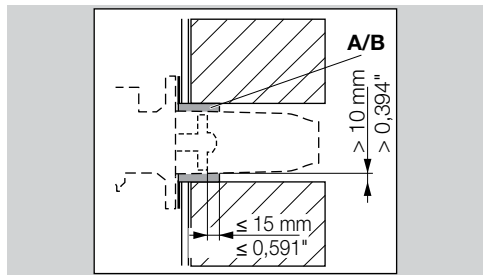

→ Burners with extension:

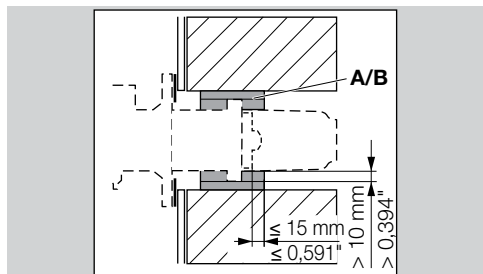

### 3.3 Installation on the furnace

→ When installing, always ensure that when the burner is mounted, it is sealed tightly on the furnace wall.

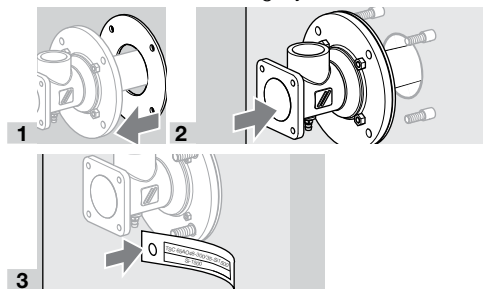

→ Attach the ceramic tube type label.

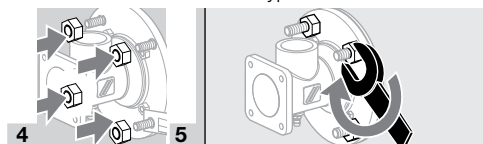

### 3.4 Air connection, gas connection

#### BIC

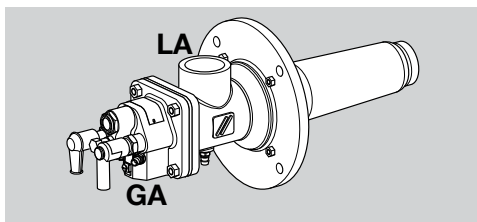

#### BICW

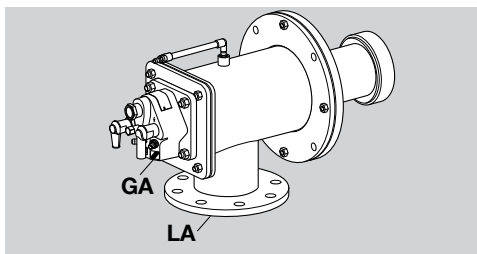

Type	Gas connection GA	Air connection LA*
BIC 50	Rp 1/2	Rp 1/2
BICA 65	Rp 1/2	Ø 48 mm
BIC 65	Rp 3/4	Rp 1 1/2
BIC 80	Rp 3/4	Rp 2
BIC 100	Rp 1	Rp 2
BIC 125	Rp 1 1/2	DN 65
BIC 140	Rp 1 1/2	DN 80
BICW 65	Rp 3/4	DN 65
BICW 80	Rp 3/4	DN 80
BICW 100	Rp 1	DN 80
BICW 125	Rp 1 1/2	DN 100
BICW 140	Rp 1 1/2	DN 125

\* Up to burner size 100, threaded connection; as from burner size 125, flanged connection, BICA 65: tube connection.

→ Threaded connection to DIN 2999, flange dimensions to DIN 2633, PN 16.

→ Install flexible tubes or bellows units to prevent mechanical stress or transmission of vibration.

→ Ensure that the gaskets are undamaged.

#### **⚠ DANGER**

Risk of explosion!

– Ensure the connection is air-tight.

→ On delivery, the threaded gas connection is situated opposite the air connection; it can be rotated in increments of 90°.

#### 3.5 Connection to ANSI/NPT

→ An adapter set is required for connection to ANSI/NPT, see page 14 (9 Accessories)

Type	Gas connection GA	Air connection LA
BIC 50	½–14 NPT	1½–11.5 NPT
BIC 65	½–14 NPT	Ø 1.89"
BIC 65	¾–14 NPT	1½–11.5 NPT
BIC 80	¾–14 NPT	2–11.5 NPT
BIC 100	1–11.5 NPT	2–11.5 NPT
BIC 125	1½–11.5 NPT	Ø 2.94"
BIC 140	1½–11.5 NPT	Ø 3.57"
BICW 65	¾ NPT	Ø 2.94"
BICW 80	¾ NPT	Ø 3.57"
BICW 100	1 NPT	Ø 3.57"
BICW 125	1½ NPT	Ø 4.6"
BICW 140	1½ NPT	Ø 5.6"

→ **BIC 50 to BIC 100:** use NPT adapter **J** for air connection **LA** and NPT thread adapter **H** for gas connection **GA**.

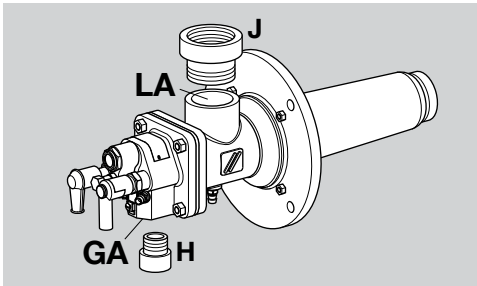

→ **BIC 125, BIC 140, BICW:** weld flange **K** to air pipe **P** for air connection **LA** and use NPT thread adapter **H** for gas connection **GA**.

### BIC 125 and BIC 140

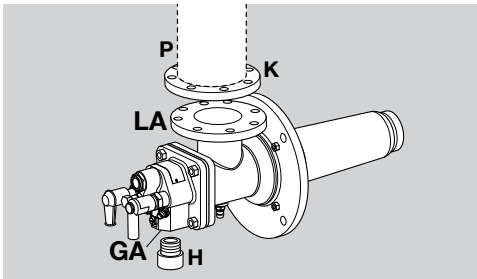

### BICW

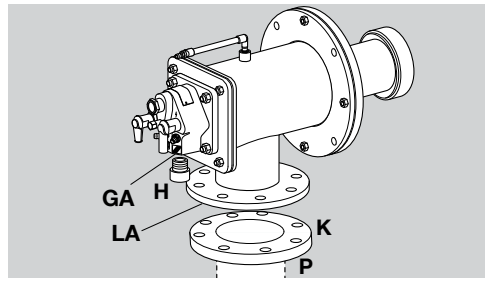

### 3.6 Pilot connections on the BIC..L

→ Air connection **la**: Rp 3/8".

→ Gas connection **ga** (as from burner size 65): Rp 1/4".

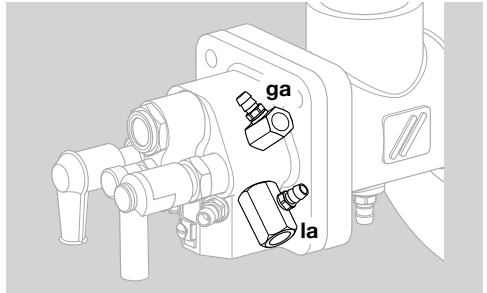

→ Pilot capacity: 1.5 kW.

### 3.7 Installing the burner insert

#### ⚠ WARNING

– **BICW:** do not damage the surface of the insulation. Avoid the formation of dust.

→ The burner insert can be rotated to the required position in increments of 90°.

**1** Insert the gas housing gasket between the burner insert and the air housing.

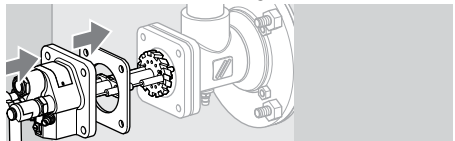

**2** Tighten burner insert in a crosswise fashion: BIC(A) 50–100 with max. 15 Nm (11 lb ft), BIC 125–140 with max. 30 Nm (22 lb ft).

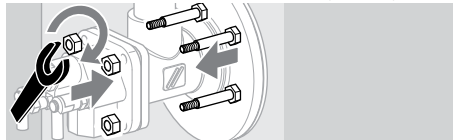

## 4 WIRING

### **⚠ DANGER**

Electric shocks can be fatal!

– Before working on possible live components, ensure the unit is disconnected from the power supply.

- For the ignition and ionization cables, use (un-screened) high-voltage cable: FZLSi 1/6 up to 180°C (356°F), Order No. 04250410, or FZLK 1/7 up to 80°C (176°F), Order No. 04250409.

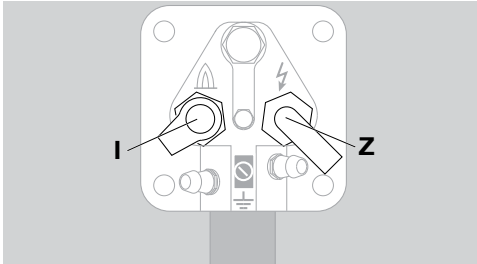

### **Flame rod I**

- Install the ionization cable well away from mains cables and interference from electromagnetic sources and avoid external electrical interference. Max. length of ionization cable – see automatic burner control unit operating instructions.
- Connect the flame rod to the automatic burner control unit via the ionization cable.

### **Spark electrode Z**

- Length of ignition cable: max. 5 m (15 ft), recommended < 1 m (40").
- For permanent ignition, max. ignition cable length 1 m (40").
- Lay the ignition cable individually and not in a metal conduit.
- Install the ignition cable separately from ionization and UV cables.
- A  $\geq 7.5$  kV,  $\geq 12$  mA ignition transformer is recommended; 5 kV for integrated pilot.

## Flame rod and spark electrode

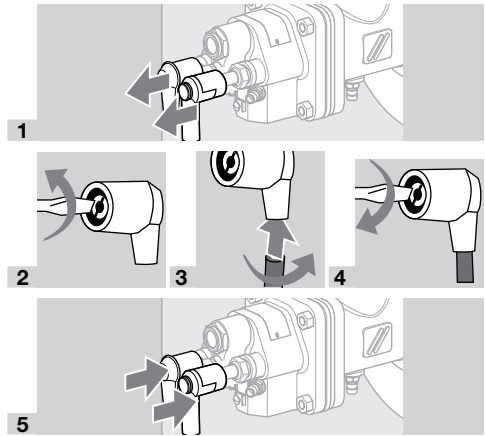

- 6 Connect the PE wire for burner ground to the burner insert. In the case of single-electrode operation, route the PE wire from the burner insert directly to the terminal on the automatic burner control unit.

### **⚠ WARNING**

High-voltage risk!

- It is essential that a high-voltage warning label be attached to the ignition cable.
- 7 For more detailed information on how to wire the ionization and ignition cables, refer to the operating instructions and connection diagrams of the automatic burner control unit and ignition transformer.

## 5 PREPARING COMMISSIONING

### 5.1 Safety instructions

- Agree on settings and commissioning of the burner with the system operator or manufacturer.
- Check the entire system, upstream devices and electrical connections.
- Note the operating instructions for individual controls.

### **⚠ DANGER**

Risk of explosion!

- Please observe the appropriate precautions when igniting the burner.
- Pre-purge the furnace chamber or radiant tube with air (5 x volume) before every ignition attempt.
- Fill the gas line to the burner carefully and correctly with gas and vent it safely into the open air – do not discharge the test volume into the furnace chamber.

### **⚠ DANGER**

Risk of poisoning!

- Open the gas and air supply so that the burner is always operated with excess air – otherwise CO will form in the furnace chamber. CO is

odourless and poisonous! Conduct a flue gas analysis.

- The burner must only be commissioned by authorized trained personnel.

- If the burner does not ignite even though the automatic burner control unit has been switched on and off several times: check the entire system.
- After ignition, monitor the flame and the gas and air pressure measured on the burner. Measure the ionization current. Switch-off threshold – see automatic burner control unit operating instructions.

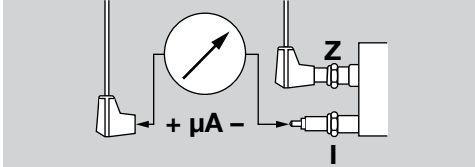

- The burner must only be ignited at low-fire rate (between 10 and 40% of the rated capacity  $Q_{max}$ ) – see type label.

### 5.2 Determining the gas and combustion air flow rates

$$Q_{Gas} = P_B / H_i$$

$$Q_{Luft} = Q_{Gas} \cdot \lambda \cdot L_{min}$$

- $Q_{gas}$ : Gas flow rate in  $m^3/h$  ( $ft^3/h$ )
- $P_B$ : Burner capacity in kW (BTU/h)
- $H_i$ : Gas heating value in  $kWh/m^3$  (BTU/ $ft^3$ )
- $Q_{air}$ : Air flow rate in  $m^3(n)/h$  (SCFH)
- $\lambda$ : Lambda, air index
- $L_{min}$ : Minimum air requirement in  $m^3(n)/m^3(n)$  (SCF/SCF)
- Information on the gas quality supplied can be obtained from the gas supply company.

### Common gas qualities

Gas type	Heating value		$L_{min}$ $m^3(n)/m^3(n)$ (SCF/SCF)
	$H_u$ kWh/ $m^3(n)$	$H_o$ BTU/ SCF	
Natural gas H	11.0	1114	10.6
Natural gas L	8.9	901	8.6
Propane	25.9	2568	24.4
Low calorific value gas	1.7–3	161–290	1.3–2.5
Butane	34.4	3406	32.3

- Data in  $kWh/m^3(n)$  refer to the lower heating value  $H_u$  and data in BTU/SCF refer to the higher heating value  $H_o$  (gross calorific value).
- A minimum air excess of 20% ( $\lambda = 1.2$ ) should be set in a cold furnace for initial adjustment since the air volume falls as the temperature rises.
- Fine adjustment should be carried out at max. furnace temperature and at as high a capacity demand as possible.

### 5.3 Notes on the flow rate curve

- If the gas density in the operating state differs from that reflected in the flow rate curve, convert the pressures according to the local operating state.

$$P_B = P_M \cdot \frac{\delta_B}{\delta_M}$$

- $\delta_M$ : Gas density reflected in the flow rate curve in  $kg/m^3$  ( $lb/ft^3$ )
- $\delta_B$ : Gas density in operating state in  $kg/m^3$  ( $lb/ft^3$ )
- $P_M$ : Gas pressure reflected in the flow rate curve
- $P_B$ : Gas pressure in operating state

### 5.4 Burners without gas measuring orifice

- 1 Read the gas pressure  $p_{gas}$  and air pressure  $p_{air}$  from the enclosed flow rate curve for cold air on the basis of the calculated flow rates  $Q$ .

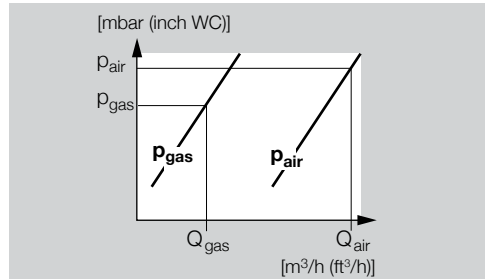

- Note possible capacity changes due to positive or negative pressures in the furnace/combustion chamber. Add positive pressures or subtract negative pressures.
- As not all the effects caused by the equipment are known, setting the burner using the pressure values is only approximate. It is possible to set the burner precisely by measuring the flow rates or flue gas.

### 5.5 Burners with gas measuring orifice

- 1 Read the differential pressure  $\Delta p_{gas}$  and air pressure  $p_{air}$  from the flow rate curve for cold air on the basis of the calculated flow rates.

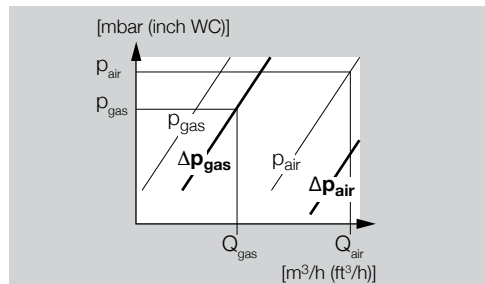

- Note possible capacity changes (air) due to pressure loss in the furnace/combustion chamber. Add positive pressures or subtract negative pressures.
- The differential gas pressure  $\Delta p_{gas}$  measured on the integrated gas measuring orifice is independent of the furnace chamber pressure.

## ⚠ WARNING

- If reducing fittings or manual valves with internal thread are installed,  $\Delta p_{\text{gas}}$  on the integrated gas measuring orifice is reduced.

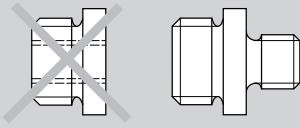

- Reducing fitting with internal and external thread: deviation from the flow rate curves may occur when the cross-section of the reducing fitting differs from that of the threaded gas connection **GA** or when a manual valve is screwed directly into the burner.
- Reducing nipple with external thread at both ends: no deviation from the flow rate curves occurs.
- Ensure an undisturbed flow to the measuring orifice!
- As not all the effects caused by the equipment are known, setting the burner using the pressure values is only approximate. It is possible to set the burner precisely by measuring the flow rates or flue gas.

## 5.6 Restrictors

- The air volume required for the low-fire rate at a given air pressure is determined by the ignition position of a butterfly valve, a bypass hole in the air valve or an external bypass with restrictor.
- Burners as from construction stage E (see type label) are equipped with gas flow adjustment to replace the restrictor in the gas pipe.

## 5.7 Hot air compensation

- The combustion air pressure  $p_{\text{air}}$  must be increased in hot air operating mode ( $\lambda = \text{constant}$ ).

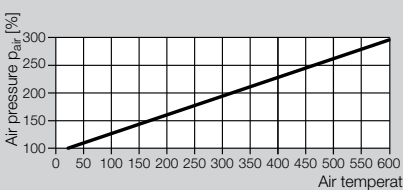

- The gas pressure is increased by 5–10 mbar.
- The total burner capacity  $P_{\text{gas}}$  rises as the air temperature increases.

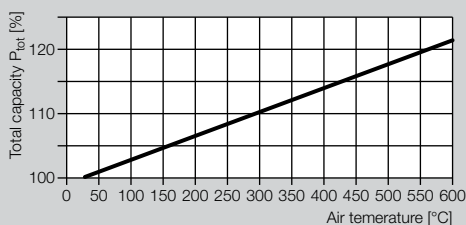

## 5.8 Burners with electrodes with air connection

- Burner head marking (..D) or (..E)

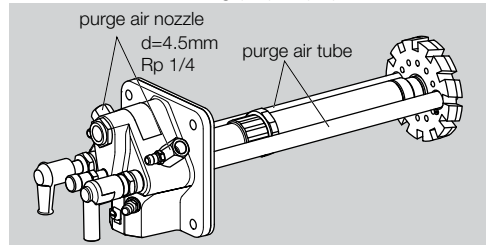

Pressures for purges electrodes

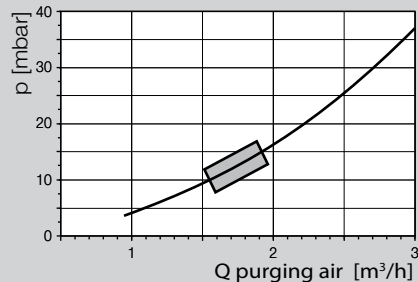

- A purge air volume of approx. 1.5 to 2 m³/h per electrode is recommended.
- The purge air may not be switched off until the furnace is cold and formation of condensation is no longer possible.

## 5.9 Setting the air pressure for low fire and high fire

- 1 Shut off the gas and air supply.

### BIC

- Air measuring nipple **L**, outside dia. = 9 mm (0.35").

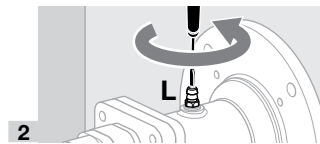

- 2 → Loosen the screw 2 turns.

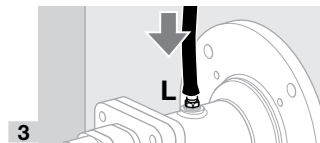

- 3 → Fully open the air supply.

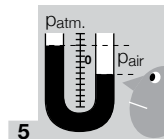

- 4 →  $p_{\text{atm}}$  = atmospheric pressure.

### BICA

- Air measuring nipple **L**, outside dia. = 9 mm (0.35").



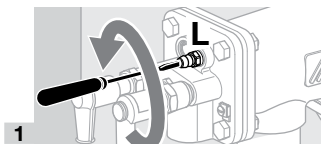

1  
→ Loosen the screw 2 turns.

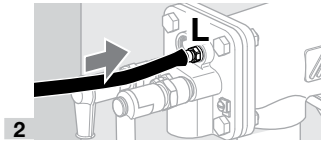

2  
3 Fully open the air supply.

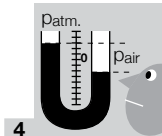

4  
→  $p_{atm.}$  = atmospheric pressure.

### Low-fire rate

→ The burner must only be ignited at low-fire rate (between 10 and 40% of the rated capacity  $Q_{max}$  – see page 2 (2.1 Type label)).

5 Reduce the air supply on the air control valve and set the desired low-fire rate, e.g. using a limit switch or mechanical stop.

→ On air control valves with bypass, the bypass orifice should be determined on the basis of the required flow rate and the existing supply pressure if required.

### High-fire rate

6 Set the air control valve to high-fire rate.

7 Set the required air pressure  $p_{air}$  on the air restrictor upstream of the burner.

8 When using air restricting orifices: check the air pressure  $p_{air}$ .

### 5.10 Preparing the gas pressure measurement for low fire and high fire

1 Connect all measuring devices for subsequent fine adjustment of the burner.

→ Leave the gas supply closed.

→ Gas measuring nipple **G**, outside dia. = 9 mm (0.35").

### 5.11 Burners without gas measuring orifice

1 Read the gas pressure  $p_{gas}$  for the required flow rate  $Q$  from the enclosed flow rate curve for cold air.

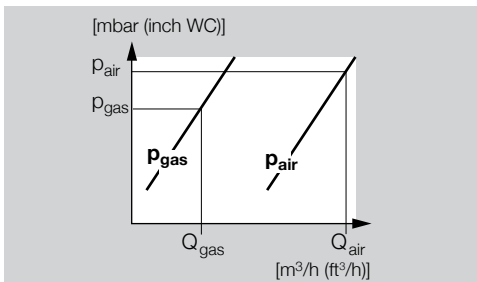

### BIC..50

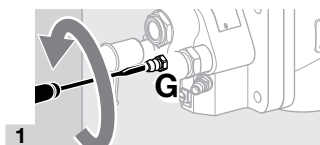

1  
→ Loosen the screw 2 turns.

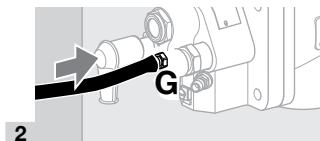

2

### BICA

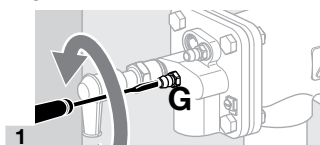

1  
→ Loosen the screw 2 turns.

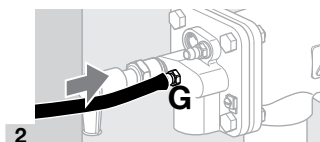

2

### 5.12 Burners with gas measuring orifice

1 Read the differential pressure for the required gas flow rate  $Q$  from the enclosed flow rate curve for cold air.

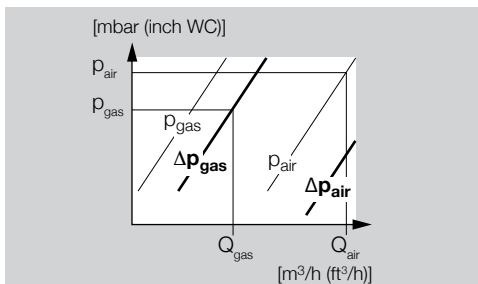

2  $p_1$ : gas pressure upstream of the measuring orifice,  $p_2$ : gas pressure downstream of the measuring orifice. Measuring range: select approx. 15 mbar.

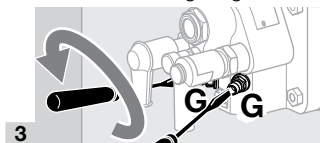

3  
→ Loosen the screws 2 turns.

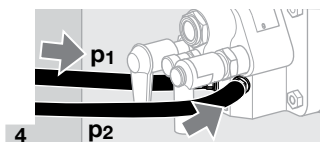

4

### 5.13 Integrated pilot on the BIC..L

- Air pressure test nipple **I**, outside dia. = 9 mm (0.35").
- Gas pressure test nipple **g**, outside dia. = 9 mm (0.35").

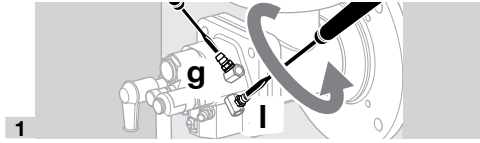

- Loosen the screws 2 turns.

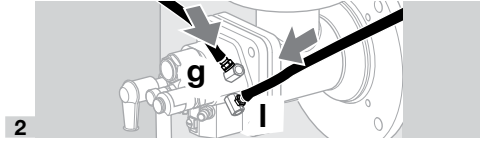

- Pilot:  
 $p_{\text{gas}} = 30\text{--}50 \text{ mbar}$ ,  
 $p_{\text{air}} = 30\text{--}50 \text{ mbar}$ .
- Check flame stability and ionization current.
- The gas and air pressure of the integrated pilot must be higher than the gas and air pressure of the main burner.

## 6 COMMISSIONING

### 6.1 Igniting and adjusting the burner

#### ⚠ WARNING

- Ensure adequate ventilation of the furnace chamber before each burner start!
- The burner body will become hot during operation with preheated combustion air. Provide protection against accidental contact as required.
- 1 All valves of the installation must be checked for tightness before ignition.

### 6.2 Setting the low-fire rate

- 1 Set the valves to ignition position.
- 2 Limit the maximum gas volume.
- Should an adjustable gas restrictor be installed upstream of the burner, open the restrictor by approx. a quarter.
- **On burners with integrated gas flow adjustment ( BIC 65–140):** on delivery, the flow rate restrictor is 100% open. Close the flow rate restrictor with approx. 10 turns:

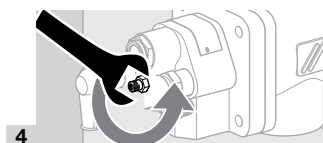
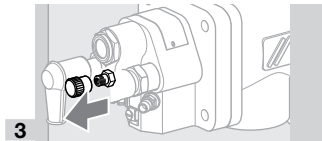

- Loosen the lock nut only.

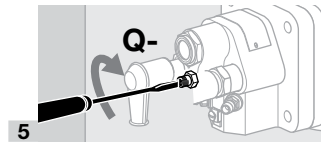

- Set flow rate **Q**.

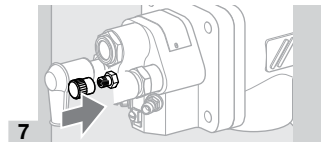

- 8 Gaszufuhr öffnen.
- 9 Ignite the burner.
- The safety time of the automatic burner control unit starts to elapse.
- 10 If no flame forms, check and adjust the gas and air pressures of the start gas adjustment.
- 11 In the case of operation with bypass (e.g. when using an air/gas ratio control): check the bypass nozzle and adjust if required.
- 12 In the case of operation without bypass (e.g. when using an air/gas ratio control without bypass): increase the low-fire rate setting.
- 13 Check the basic setting or bypass of the air control valve.
- 14 Check the position of the restrictor in the air line.
- 15 Check the fan.
- 16 Reset the automatic burner control unit and re-ignite the burner.
- The burner ignites and proceeds to normal operation.
- 17 Check flame stability and ionization current at low-fire rate. Switch-off threshold – see automatic burner control unit operating instructions.

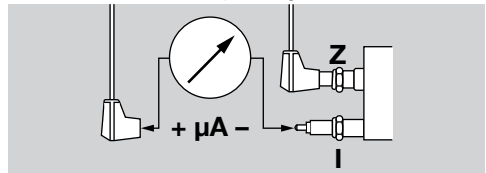

- 18 Monitor flame formation.
- 19 Adjust the low-fire rate settings if required.
- 20 If no flame is detected – see page 14 (8 Assistance in the event of malfunction).

### 6.3 Setting the high-fire rate

- 1 Set the air and gas circuit of the burner to high fire while continuously monitoring the flame.
- Avoid CO formation – always operate the burner with excess air when starting up!

→ **Burners without gas measuring orifice:** when the desired maximum valve positions are reached, set the gas pressure  $p_{\text{gas}}$  using the restrictor upstream of the burner.

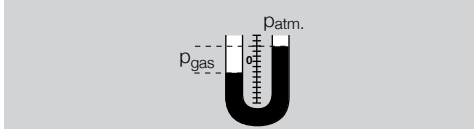

→ **Burners with gas measuring orifice:** set the differential pressure  $\Delta p_{\text{gas}}$  using the gas restrictor or via the integrated flow adjustment.

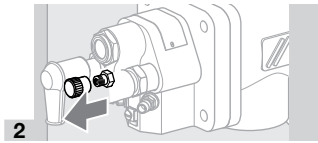
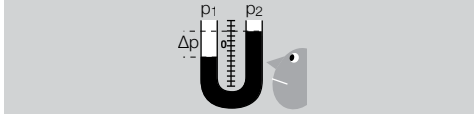

2

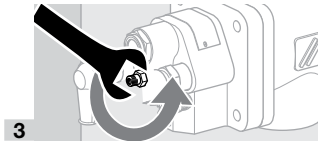

3

→ Turn the lock nut 1/4 turn to the left only.

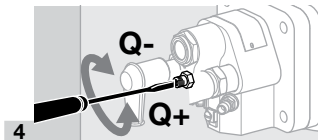

4

→ Set flow rate  $Q$ .



5

→ Tighten the lock nut. Do not alter the flow rate setting!

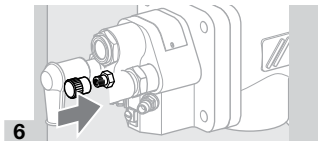

6

#### 6.4 Readjusting the air flow rate

- 1 Check the air pressure  $p_{\text{air}}$  on the burner and adjust using the air restrictor if required.
- 2 When using air restricting orifices: check the air pressure  $p_{\text{air}}$  and rework the orifice if required.

#### **⚠ DANGER**

Risk of explosion and poisoning in case of burner adjustment with insufficient air!

– Adjust the gas and air supply so that the burner is always operated with excess air – otherwise CO will form in the furnace chamber. CO is odourless and poisonous! Conduct a flue gas analysis.

- 3 Measure the gas and air flow rates if possible. Determine the lambda value and readjust the settings if required.

#### 6.5 Tightness test

#### **⚠ DANGER**

Escaping gas!

Danger from a leakage at the gas connections.

- Check the gas connections on the burner for leaks immediately after commissioning the burner.

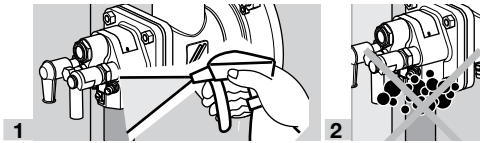

1

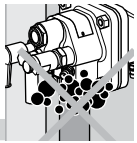

2

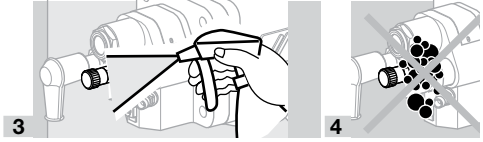

3

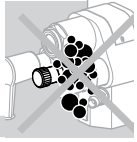

4

→ Avoid condensation due to the furnace atmosphere entering the burner body. While the burner is switched off, at furnace temperatures above 500°C (932°F), it must be cooled with a low air volume – see page 11 (6.6 Cooling air).

#### 6.6 Cooling air

→ While the burner is switched off and depending on the furnace temperature, there must be a certain air flow for cooling the burner components.

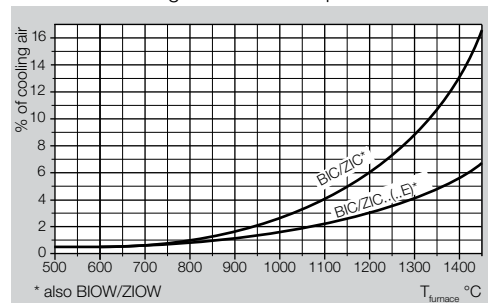

→ Diagram: the cooling air percentage specified in the diagram refers to the operating flow rate for air.  
→ Leave the air fan switched on until the furnace has cooled down completely.

#### 6.7 Blocking and recording the settings

- 1 Produce a measurement report.
- 2 Set the burner to low fire and check the settings.
- 3 Set the burner to low and high fire several times while monitoring the pressure settings, flue gas values and flame patterns.

- 4 Remove the measuring devices and close off the test nipples – tighten the grub screws.
- 5 Block and seal the adjusting elements.
- 6 Induce a flame failure, e.g. by pulling the terminal boot off the flame rod. The flame detector must close the gas safety valve and signal a fault.
- 7 Switch the system on and off several times while monitoring the automatic burner control unit.
- 8 Produce an acceptance report.

### **⚠ DANGER**

Risk of explosion in case of CO being formed in the furnace chamber! CO is odourless and poisonous!

An incorrect change of the burner settings may change the gas/air ratio and lead to unsafe operating conditions:

- All interventions may only be carried out by qualified gas technicians.

## **7 MAINTENANCE**

- Maintenance and function check every six months. If the media are highly contaminated, this interval should be reduced.

### **⚠ DANGER**

Risk of explosion!

- Please observe the appropriate precautions when igniting the burner.
- Maintenance work on the burner must be carried out by authorized trained personnel only.

### **⚠ DANGER**

Risk of burning!

- Outflowing flue gases and burner components are hot.

- We recommend that all the gaskets removed during maintenance work be replaced. The appropriate gasket set is available separately as a spare part.

- 1 Check the ionization and ignition cables.
- 2 Measure the ionization current.

- The ionization current must be at least 5  $\mu\text{A}$  and must not vary.

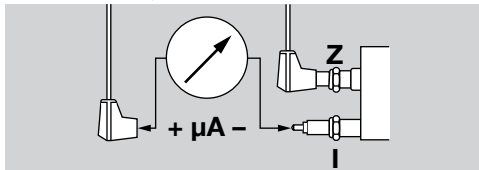

- 3 Disconnect the system from the electrical power supply.
- 4 Shut off the gas and air supply – do not change the restrictor settings.

### **7.1 Checking the spark electrode and flame rod**

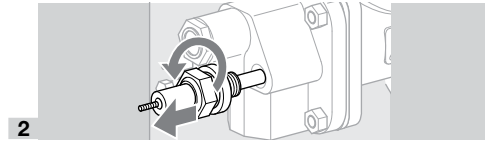
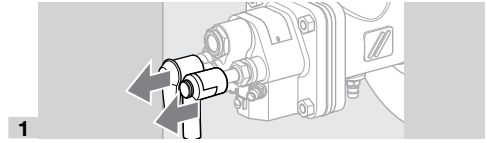

- Ensure that the electrode length does not change.

- 3 Remove dirt from electrodes or insulators.

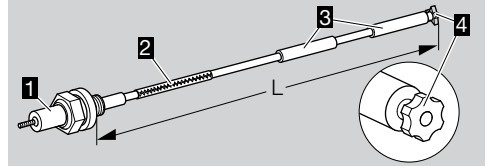

- 4 If the star 4 or insulator 3 is damaged, replace the electrode.

- Before changing the electrode, measure the total length L.

- 5 Connect the new electrode with the spark plug 1 using the dowel pin 2.

- 6 Adjust spark plug and electrode to the measured total length L.

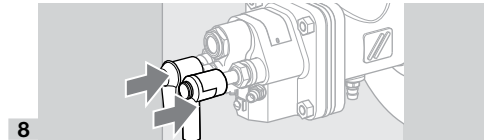
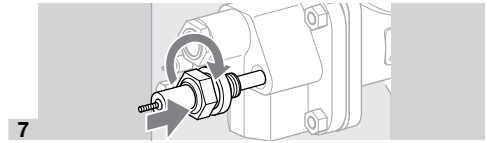

- Turning the spark plug makes it easier to feed the electrode into the burner insert.

### **7.2 Checking the burner**

#### **Removing and installing burner insert BICW**

- Do not damage the surface of the insulation.
- Avoid the formation of dust.

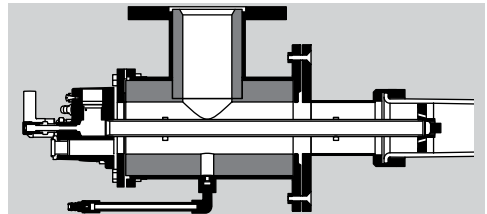

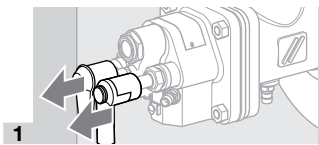

1

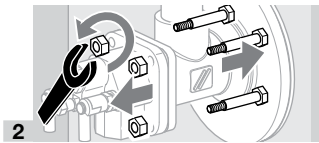

2

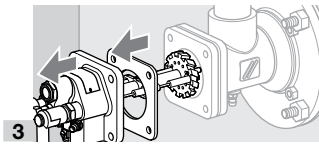

3

→ If the burner insert is dismantled, the gas housing gasket will have to be renewed.

4 Place the burner insert in a safe place.

→ Depending on the amount of dirt or wear: replace the spark electrode/flame rod and dowel pin during servicing – see page 12 (7.1 Checking the spark electrode and flame rod).

→ Check burner head for dirt and thermal cracks.

### **⚠ WARNING**

Risk of injury!

– Burner heads have sharp edges.

→ When replacing any burner components: apply ceramic paste to the screw connections in order to avoid cold-setting – see page 14 (9 Accessories).

5 Check the electrode positions.

### **BIC..50**

→ The front part of the insulator must protrude 4 mm from the burner air disc.

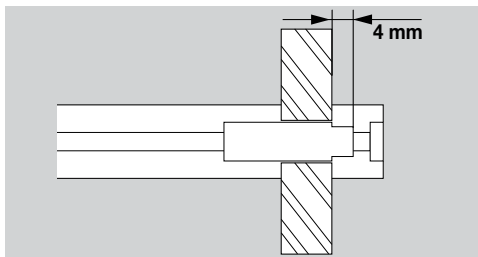

### **BIC..65 to 140**

→ The insulator must be flush with the front edge of the burner air disc.

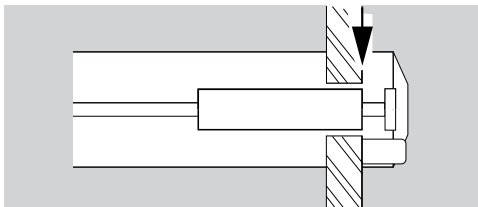

→ Distance of spark electrode from ground pin or gas nozzle:  $2 \pm 0.5 \text{ mm}$  ( $0.08 \pm 0.02''$ ).

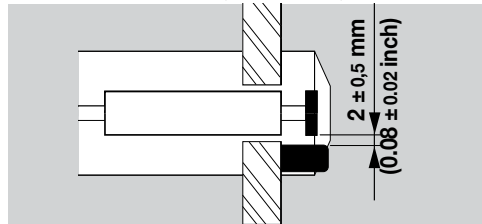

6 When the furnace chamber has cooled down, check the burner tube and burner block through the furnace flange.

→ Replace the gas housing gasket.

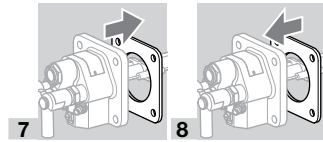

7

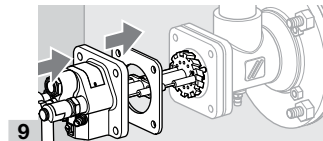

8

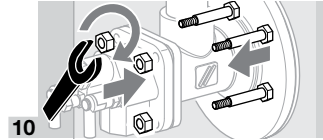

9

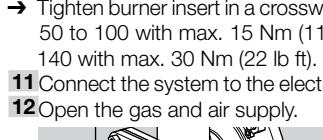

10

→ Tighten burner insert in a crosswise fashion: BIC(A) 50 to 100 with max. 15 Nm (11 lb ft), BIC 125 to 140 with max. 30 Nm (22 lb ft).

11 Connect the system to the electrical power supply.

12 Open the gas and air supply.

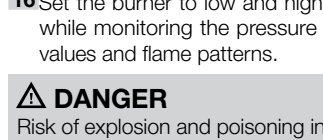

13

15 Set the burner to low fire and compare the pressure settings to those stated in the acceptance report.

16 Set the burner to low and high fire several times while monitoring the pressure settings, flue gas values and flame patterns.

17 Produce a maintenance report.

## 8 ASSISTANCE IN THE EVENT OF MALFUNCTION

### **⚠ DANGER**

Electric shocks can be fatal!

- Before working on possible live components, ensure the unit is disconnected from the power supply.

### **⚠ DANGER**

Risk of injury!

Burner heads have sharp edges.

- Burner inspection must only be performed by authorized trained personnel.

→ If no issues are found when checking the burner, proceed to the automatic burner control unit and check for faults in accordance with the relevant operating instructions.

### **? Fault**

#### **! Cause**

- Remedy

### **? Burner does not function.**

#### **! Valves do not open.**

- Check the voltage supply and wiring.

#### **! Tightness control signals a fault.**

- Check the valves for tightness.
- Note the tightness control operating instructions.

#### **! Control valves do not move to low-fire rate position.**

- Check the impulse lines.

#### **! Gas inlet pressure is too low.**

- Check the filter for dirt.
- Check the gas supply.

#### **! Air inlet pressure is too low.**

- Check the fan and air supply.

#### **! Gas and air pressures on the burner are too low.**

- Check the restrictors.
- Check/adjust the start rate setting, see operating instructions for solenoid valve.

#### **! Automatic burner control unit does not function correctly.**

- Check the device fuse.
- Note the automatic burner control unit operating instructions.

#### **! Automatic burner control unit signals a fault.**

- Check the ionization cable.
- Check the ionization current. The ionization current must be at least 5 µA – stable signal.
- Check whether the burner is adequately grounded.
- Note the automatic burner control unit operating instructions.

#### **! No ignition spark is created.**

- Check the ignition cable.

- Check the voltage supply and wiring.
- Check whether the burner is adequately grounded.
- Check the electrode – see page 12 (7 Maintenance).

#### **! Defective insulator on the electrode, ignition spark jumps over incorrectly.**

- Check the electrode.

### **? Burner performs a fault lock-out after operating faultlessly in normal operation.**

#### **! Incorrect gas and air flow rate settings.**

- Check the differential pressures for gas and air.

#### **! Automatic burner control unit signals a fault.**

- Check the ionization cable.
- Check the ionization current. The ionization current must be at least 5 µA – stable signal.

#### **! Burner head is dirty.**

- Clean gas and air bore holes and air slots.
- Remove deposits.

#### **! Excessive pressure fluctuations in the combustion chamber.**

- Ask Honeywell Kromschroder for control concepts.

## 9 ACCESSORIES

### 9.1 Ceramic paste

For avoiding cold-setting on screw connections after replacing burner components. Order No.: 050120009.

### 9.2 Adapter set



For connecting, burners BIC, BICA to NPT/ANSI connections.

Burner	Adapter set	Gas connection	Air connection	Order No.
BIC 50	BR 50 NPT	½"-14 NPT	1½"-11.5 NPT	74922630
BIC 65	BR 65 NPT	¾"-14 NPT	1½"-11.5 NPT	74922631
BICA 65*	–	½"-14 NPT	Ø 1.89"	75456281
BIC 80	BR 80 NPT	¾"-14 NPT	2"-11.5 NPT	74922632
BIC 100	BR 100 NPT	1"-11.5 NPT	2"-11.5 NPT	74922633
BIC 125	BR 125 NPT	1½"-11.5 NPT	Ø 2.94"	74922634
BIC 140	BR 140 NPT	1½"-11.5 NPT	Ø 3.57"	74922635

\* An NPT thread adapter is required for connection to the gas circuit only.

Adapted set for BICW on request.

### 9.3 Integrated pilot connections

Nozzle set BR 65–140 with NPT thread is required for integrated pilots (sizes 165 and 200 on request).

Gas type	Order No.
Natural gas	74922638
LPG	74922639

### 9.4 Gasket sets for reverse flow pressure

For reverse flow pressures of 100 mbar < p < 500 mbar. "Gasket set BR XY 500 mbar" contains a mounting gasket, a gas housing gasket and a burner tube gasket made of pressure-resistant gasket material. The standard gaskets must be replaced with the gaskets from the gasket set for reverse flow pressure. The gasket sets are available on request.

## 10 TECHNICAL DATA

Gas supply pressure and air supply pressure each depend on the use and gas type.

#### Gas and air pressures:

see burner diagrams at [www.docuthek.com](http://www.docuthek.com). Special gaskets are available on request for air pressures of > 100 mbar (39.4 "WC) (e.g. reverse flow pressure in the furnace).

#### Burner flow rate curves:

A web app to view the burner flow rate curves is available at [www.adlatus.org](http://www.adlatus.org).

#### Gas types:

natural gas, LPG (gaseous), coke oven gas, town gas, low calorific value gas and biogas; other types of gas on request.

#### Combustion air:

The air must be dry and clean in all temperature conditions and must not contain condensate.

#### Overall lengths:

100 to 500 mm (3.9 to 19.7 inches) or 50 to 450 mm (2 to 17.7 inches), length increments: 100 mm (3.94 inches) (other lengths available on request).

#### Control type:

staged: On/Off,  
modulating: constant  $\lambda$  value.

#### Flame control:

with flame rod (UV control as an option).

#### Ignition:

direct spark ignition; integrated pilot as an option.  
Storage temperature: -20°C to +40°C.

#### Burner body:

BIC: GG,  
BICA: AISi,  
BICW: St + internal insulation.  
Most of the burner components are made of corrosion-resistant stainless steel.

#### Ambient conditions:

-20°C to +180°C (68°F to 356°F) (outside the thermoprocessing system); no condensation permitted, painted surfaces may corrode.

**Maximum furnace temperature:** 1450°C (2642°F)

#### Maximum air temperature:

BIC: up to 450°C (842°F),  
BICA: up to 200°C (392°F),  
BICW: up to 600°C (1112°F).

### 10.1 Ceramic tube

Material: SI-1500.

Maximum furnace temperature: up to 1450°C (2642°F).

Maximum air temperature: up to 600°C (1112°F).

Maximum material temperature: up to 1500°C (2732°F).

### 10.2 REACH Regulation

applies to BICW only.

Information pursuant to REACH Regulation No. 1907/2006, Article 33.

Insulation contains refractory ceramic fibres (RCF)/aluminium silicate wool (ASW).

RCF/ASW are listed in the Candidate List of the European REACH Regulation No. 1907/2006.

## 11 LOGISTICS

### Transport

Protect the unit from external forces (blows, shocks, vibration).

Transport temperature: see page 15 (10 Technical data).

Transport is subject to the ambient conditions described.

Report any transport damage on the unit or packaging without delay.

Check that the delivery is complete.

### Storage

Storage temperature: see page 15 (10 Technical data).

Storage is subject to the ambient conditions described.

Storage time: 6 months in the original packaging before using for the first time. If stored for longer than this, the overall service life will be reduced by the corresponding amount of extra storage time.

## 12 DISPOSAL

Devices with electronic components:

### WEEE Directive 2012/19/EU – Waste Electrical and Electronic Equipment Directive



At the end of the product life (number of operating cycles reached), dispose of the packaging and product in a corresponding recycling centre. Do not dispose of the unit with the usual domestic refuse. Do not burn the product. On request, old units may be returned carriage paid to the manufacturer in accordance with the relevant waste legislation requirements.

# 13 DECLARATION OF INCORPORATION

Honeywell

according to 2006/42/EC, Annex II, No. 1B  
The product BIC/BICA/BICW is a partly completed machine pursuant to Article 2g and is designed exclusively for installation in or assembly with another machine or other equipment.

The following essential health and safety requirements in accordance with Annex I of this Directive are applicable and have been fulfilled:  
Annex I, Articles 1.1.3, 1.1.5, 1.3.2, 1.3.4., 1.5.2, 1.7.4, 1.5.10.

The relevant technical documentation has been compiled in accordance with part B of Annex VII and will be sent to the relevant national authorities on request as a digital file.

The following (harmonized) standards have been applied:

- EN 746-2:2010 – Industrial thermoprocessing equipment; Safety requirements for combustion and fuel handling systems
- EN ISO 12100:2010 – Safety of machinery – General principles for design – Risk assessment and risk reduction (ISO 12100:2010)

The following EU Directives are fulfilled:  
RoHS II (2011/65/EU)

The partly completed machine may only be commissioned once it has been established that the machine into which the product mentioned above is to be incorporated complies with the provisions of the Machinery Directive 2006/42/EC.  
Elster GmbH

**Einbauerklärung**  
nach 2006/42/EG, Anhang II, Nr. 1B

**/ Declaration of Incorporation**  
/ according to 2006/42/EC, Annex II No. 1B

Folgendes Produkt / The following product:

Bezeichnung:  
Description  
Typenbezeichnung / Type:  
Markenname / Branding:

Brenner für Gas  
Burner for gas  
BIC, BICA, ZIC, BIC, BICA, ZIC  
BICW, ZICW, BICW, ZICW  
**krom/schroder**

ist eine unvollständige Maschine nach Artikel 2g und ausschließlich zum Einbau in oder zum Zusammenbau mit einer anderen Maschine oder Ausrüstung vorgesehen.  
is a partly completed machine pursuant to Article 2g and is designed exclusively for installation in or assembly with another machine or other equipment.

Folgende grundlegende Sicherheits- und Gesundheitsschutzanforderungen gemäß Anhang I dieser Richtlinie kommen zur Anwendung und wurden eingehalten:  
The following essential health and safety requirements in accordance with Annex I of this Directive are applicable and have been fulfilled:

Anhang I, Artikel / Annex I, Article  
1.1.3, 1.1.5, 1.3.2, 1.3.4, 1.5.2, 1.7.4, 1.5.10

Die speziellen technischen Unterlagen gemäß Anhang VII B wurden erstellt und werden der zuständigen nationalen Behörde auf Verlangen in elektronischer Form überreicht.  
The relevant technical documentation has been compiled in accordance with part B of Annex VII and will be sent to the relevant national authorities on request as a digital file.

Folgende (harmonisierte) Normen wurden angewandt: / The following (harmonized) standards have been applied:  
EN 746-2:2010 – Industrielle Thermoprocessinganlagen; Sicherheitsanforderungen an Feuerungen und Brennstoffhandlingsystem  
= Industrial thermoprocessing equipment; Safety requirements for combustion and fuel handling systems  
EN ISO 12100:2010 – Sicherheit von Maschinen – Allgemeine Gestaltungsgrundsätze – Risikoanalyse und Risikoreduzierung (ISO 12100:2010)  
= Safety of machinery – General principles for design – Risk assessment and risk reduction (ISO 12100:2010)

Folgende EU-Richtlinien wurden erfüllt: / The following EU directives are fulfilled:

RoHS II (2011/65/EU)

Die unvollständige Maschine darf erst dann in Betrieb genommen werden, wenn festgestellt wurde, dass die Maschine, in der das oben bezeichnete Produkt eingebaut werden soll, den Bestimmungen der Richtlinie für Maschinen (2006/42/EC) entspricht.  
The partly completed machine may only be commissioned once it has been established that the machine into which the product mentioned above is to be incorporated complies with the provisions of the Machinery Directive 2006/42/EC.

Lotte (Böden)

*M. Rieken, S. Escher*

**M. Rieken, S. Escher**  
Konstrukteur / Designer

Datum / Date

10.07.2019

Elster GmbH

Postfach 38 09

D-06103 Cospothen

Ströheweg 1

04505 Lota (Böden)

TEL +49 (0)941 12 14-0

Fax +49 (0)941 12 14-70

mailto:hs@elster.com

www.elster.com

## 14 CERTIFICATION

### 14.1 Eurasian Customs Union



The products BIC meet the technical specifications of the Eurasian Customs Union.

### 14.2 China RoHS

Directive on the restriction of the use of hazardous substances (RoHS) in China. Scan of the Disclosure Table China RoHS2, see certificates at [www.docuthek.com](http://www.docuthek.com).

## FOR MORE INFORMATION

The Honeywell Thermal Solutions family of products includes Honeywell Combustion Safety, Eclipse, Exothermics, Hauck, Kromschroder and Maxon. To learn more about our products, visit [ThermalSolutions.honeywell.com](http://ThermalSolutions.honeywell.com) or contact your Honeywell Sales Engineer.

Elster GmbH  
Strothweg 1, D-49504 Lotte  
T +49 541 1214-0  
hts.lotte@honeywell.com  
www.kromschroeder.com

Global centralized service deployment coordination:  
T +49 541 1214-365 or -555  
hts.service.germany@honeywell.com

Translation from the German  
© 2022 Elster GmbH

**Honeywell**  
**krom/schroder**